

**48Vin
Input**

**3.3Vout
Output**

**30Amp
Current**

**2250Vdc
Isolation**

**Eighth-brick
DC/DC Converter**

The PQ60033ETL30 PowerQor® Tera eighth-brick converter is a next-generation, board-mountable, isolated, fixed switching frequency DC/DC converter that uses synchronous rectification to achieve extremely high conversion efficiency. The power dissipated by the converter is so low that a heatsink is not required, which saves cost, weight, height, and application effort. All of the power and control components are mounted to the multi-layer PCB substrate with high-yield surface mount technology. Since the PowerQor converter has no explicit thermal interfaces, it is extremely reliable. RoHS Compliant (see page 12).

PowerQor® Tera



PQ60033ETL30 Module

Operational Features

- High efficiency, 90% at full load
- Delivers up to 30 amps of output current with minimal derating - no heatsink required
- Wide input voltage range: 35V – 75V, with 100V 100ms input voltage transient capability
- Fixed frequency switching provides predictable EMI performance
- No minimum load requirement means no preload resistors required

Mechanical Features

- Industry standard eighth-brick pin-out configuration
- Industry standard size: 0.90" x 2.3" (22.9x58.4mm)
- Total height only 0.320" (8.13mm), permits better air-flow and smaller card pitch
- Total weight: 0.85 oz. (24 grams)
- Flanged pins designed to permit surface mount soldering (avoid wave solder) using FPiP technique

Control Features

- On/Off control referenced to input side (positive and negative logic options are available)
- Remote sense for the output voltage compensates for output distribution drops
- Output voltage trim permits custom voltages and voltage margining

Protection Features

- Input under-voltage lockout disables converter at low input voltage conditions
- Output current limit and short circuit protection protects converter and load from permanent damage and consequent hazardous conditions
- Active back bias limit prevents damage to converter from external load induced pre-bias
- Output over-voltage protection protects load from damaging voltages
- Thermal shutdown protects converter from abnormal environmental conditions

Safety Features

- 2250V, 30 MΩ input-to-output isolation provides input/output ground separation
- UL 60950-1 recognized (US & Canada), basic insulation rating
- TUV certified to EN60950-1
- Meets 72/23/EEC and 93/68/EEC directives which facilitates CE Marking in user's end product
- Board and plastic components meet UL94V-0 flammability requirements

Input: 35-75 V
Output: 3.3 V
Current: 30 A
Package: Eighth-brick

MECHANICAL DIAGRAM

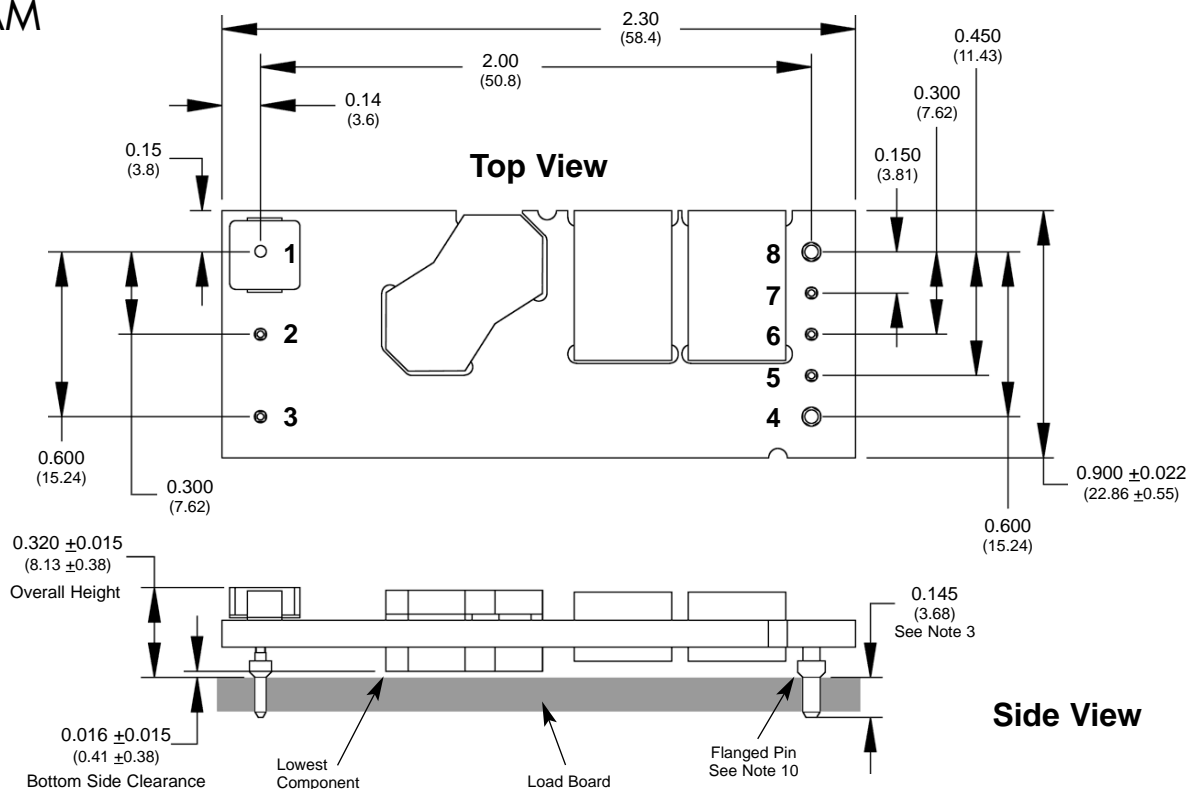

NOTES

- 1) Pins 1-3, 5-7 are 0.040" (1.02mm) diameter. with 0.080" (2.03mm) diameter standoff shoulders.
- 2) Pins 4 and 8 are 0.062" (1.57 mm) diameter with 0.100" (2.54 mm) diameter standoff shoulders.
- 3) Other pin extension lengths available. Recommended pin length is 0.03" (0.76mm) greater than the PCB thickness.
- 4) All Pins: Material - Copper Alloy
Finish - Matte Tin over Nickel plate
- 5) Undimensioned components are shown for visual reference only.
- 6) All dimensions in inches (mm)
Tolerances: x.xx ±0.02 in. (x.x ±0.5mm)
x.xxx ±0.010 in. (x.xx ±0.25mm)
- 7) Weight: 0.85 oz (24 g) typical
- 8) Workmanship: Meets or exceeds IPC-A-610C Class II
- 9) UL/TUV standards require a clearance greater than 0.04" (1.02mm) between input and output for Basic insulation. This issue should be considered if any copper traces are on the top side of the user's board. Note that the ferrite core shown at left above is considered part of the input/primary circuit and that the two ferrite cores shown at the right above are considered part of the output/secondary circuit.
- 10) The flanged pins are designed to permit surface mount soldering (allowing to avoid the wave soldering process) through the use of the flanged pin-in-paste technique.

PIN DESIGNATIONS

Pin No.	Name	Function
1	Vin(+)	Positive input voltage
2	ON/OFF	TTL input to turn converter on and off, referenced to Vin(-), with internal pull up.
3	Vin(-)	Negative input voltage
4	Vout(-)	Negative output voltage
5	SENSE(-)	Negative remote sense ¹
6	TRIM	Output voltage trim ²
7	SENSE(+)	Positive remote sense ³
8	Vout(+)	Positive output voltage

Notes:

1. SENSE(-) should be connected to Vout(-) either remotely or at the converter.
2. Leave TRIM pin open for nominal output voltage.
3. SENSE(+) should be connected to Vout(+) either remotely or at the converter.

PQ60033ETL30 ELECTRICAL CHARACTERISTICS

T_A=25°C, airflow rate=300 LFM, V_{in}=48Vdc unless otherwise noted; full operating temperature range is -40°C to +100°C ambient temperature with appropriate power derating. Specifications subject to change without notice.

Parameter	Min.	Typ.	Max.	Units	Notes & Conditions
ABSOLUTE MAXIMUM RATINGS					
Input Voltage					
Non-Operating			100	V	Continuous
Operating			75	V	Continuous
Operating Transient Protection			100	V	100ms transient, square wave
Isolation Voltage (input to output)			2250	V	Basic insulation, Pollution Degree 2
Operating Temperature	-40		100	°C	
Storage Temperature	-55		125	°C	
Voltage at ON/OFF input pin	-2		18	V	
INPUT CHARACTERISTICS					
Operating Input Voltage Range	35	48	75	V	
Input Under-Voltage Lockout					
Turn-On Voltage Threshold	31.5	32.6	33.7	V	
Turn-Off Voltage Threshold	29.6	30.6	31.6	V	
Lockout Voltage Hysteresis	1.9	2.0	2.1	V	
Maximum Input Current			3.2	A	100% Load, 35 V _{in} , nominal V _{out}
No-Load Input Current	0		75	mA	
Disabled Input Current		6	10	mA	
Inrush Current Transient Rating			0.01	A ² s	
Response to Input Transient		150		mV	1000V/ms input transient
Input Reflected Ripple Current		1.5		mA	RMS thru 10µH inductor; Figures 13 & 15
Input Terminal Ripple Current		50		mA	RMS; Figures 13 & 14
Recommended Input Fuse			20	A	Fast blow external fuse recommended
Input Filter Component Values (L\C)			1.0 \ 3.3	µH\µF	Internal values, see Figure E
Recommended External Input Capacitance		47		µF	Typical ESR 0.1-0.2Ω, see Figure 13
OUTPUT CHARACTERISTICS					
Output Voltage Set Point	3.276	3.300	3.332	V	
Output Voltage Regulation					
Over Line		±0.1 \ 3.3		%\mV	
Over Load		±0.2 \ 7.0		%\mV	
Over Temperature		±5		mV	
Total Output Voltage Range	3.261	3.300	3.349	V	Over sample, line, load, temperature & life
Output Voltage Ripple and Noise ¹					20MHz bandwidth; Figures 13 & 16
Peak-to-Peak		6	50	mV	Full Load; see Figures 13 & 16
RMS		6	20	mV	Full Load; see Figures 13 & 16
Operating Output Current Range	0		30	A	Subject to thermal derating; Figures 5 - 8
Output DC Current-Limit Inception	30.5	36	40	A	Output Voltage 10% Low
Output DC Current-Limit Shutdown Voltage		1.5		V	
Back-Drive Current Limit while Enabled		8		A	Negative current drawn from output
Back-Drive Current Limit while Disabled		10	50	mA	Negative current drawn from output
Maximum Output Capacitance Electrolytic			10	mF	3.3V _{out} at 30A Resistive Load
Maximum Output Capacitance Ceramic			5	mF	3.3V _{out} at 30A Resistive Load
DYNAMIC CHARACTERISTICS					
Input Voltage Ripple Rejection		75		dB	120 Hz; Figure 20
Output Voltage during Load Current Transient					
For a Step Change in Output Current (0.1A/µs)		120		mV	50% to 75% to 50% lout max; Figure 11
For a Step Change in Output Current (1A/µs)		180		mV	50% to 75% to 50% lout max; Figure 12
Settling Time		80		µs	To within 1% V _{out} nom
Turn-On Transient					
Turn-On Time	12	15	18	ms	Full load, V _{out} =90% nom.; Figures 9 & 10
Start-Up Inhibit Time	9	10	11	ms	-40°C to +125°C; Figure F
Restart Inhibit Time	190	200	210	ms	-40°C to +125°C; Figure F
Output Voltage Overshoot		0		%	No load capacitance, lout = 0A
EFFICIENCY					
100% Load		90		%	Figures 1 - 4
50% Load		92		%	Figures 1 - 4
TEMPERATURE LIMITS FOR POWER DERATING CURVES					
Semiconductor Junction Temperature			125	°C	Package rated to 150°C
Board Temperature			125	°C	UL rated max operating temp 130°C
Transformer Temperature			125	°C	See Figures 5 - 8 for derating curves
ISOLATION CHARACTERISTICS					
Isolation Voltage (dielectric strength)		2250		V	
Isolation Resistance		30		MΩ	
Isolation Capacitance ²		3300		pF	

Note 1: Output voltage ripple can exceed maximum specification during startup when output voltage is less than 1.4V. Additional output capacitance will mitigate this start-up ripple behavior. For applications requiring reduced output voltage ripple and noise, consult SynQor applications support (e-mail: support@synqor.com)

Note 2: Higher values of isolation capacitance can be added external to the module.

PQ60033ETL30 ELECTRICAL CHARACTERISTICS (Continued)

Parameter	Min.	Typ.	Max.	Units	Notes & Conditions
FEATURE CHARACTERISTICS					
Switching Frequency	317	333	350	kHz	
ON/OFF Control (Option P)					
Off-State Voltage	-2		0.8	V	
On-State Voltage	2.4		18	V	
ON/OFF Control (Option N)					
Off-State Voltage	2.4		18	V	
On-State Voltage	-2		0.8	V	
ON/OFF Control (Either Option)					Figures A & B
Pull-Up Voltage			5	V	
Pull-Up Resistance		10		kΩ	
Output Voltage Trim Range	-20		+10	%	Measured across Pins 8 & 4; Figure C
Output Voltage Remote Sense Range			+10	%	Measured across Pins 8 & 4
Output Over-Voltage Protection	117	120	129	%	Over full temp range; % of nominal Vout
Over-Temperature Shutdown		120		°C	Average PCB Temperature
Over-Temperature Shutdown Restart Hysteresis		10		°C	
RELIABILITY CHARACTERISTICS					
Calculated MTBF (Telcordia)		3.0		10 ⁶ Hrs.	TR-NWT-000332; 80% load, 300LFM, 40°C T _a
Calculated MTBF (MIL-217)		2.6		10 ⁶ Hrs.	MIL-HDBK-217F; 80% load, 300LFM, 40°C T _a
Field Demonstrated MTBF				10 ⁶ Hrs.	See our website for latest values

STANDARDS COMPLIANCE

Parameter	Notes
STANDARDS COMPLIANCE	
UL/cUL 60950-1	File # E194341, Basic insulation & pollution degree 2
EN60950-1	Certified by TÜV
72/23/EEC	
93/68/EEC	
Needle Flame Test (IEC 695-2-2)	Test on entire assembly; board & plastic components UL94V-0 compliant
IEC 61000-4-2	ESD test, 8kV - NP, 15kV air - NP (Normal Performance)
GR-1089-CORE	Section 7 - electrical safety, Section 9 - bonding/grounding
Telcordia (Bellcore) GR-513	

- An external input fuse must always be used to meet these safety requirements. Contact SynQor for official safety certificates on new releases or download from the [SynQor website](#).

QUALIFICATION TESTING

Parameter	# Units	Test Conditions
QUALIFICATION TESTING		
Life Test	32	95% rated V _{in} and load, units at derating point, 1000 hours
Vibration	5	10-55Hz sweep, 0.060" total excursion, 1 min./sweep, 120 sweeps for 3 axis
Mechanical Shock	5	100g minimum, 2 drops in x and y axis, 1 drop in z axis
Temperature Cycling	10	-40°C to 100°C, unit temp. ramp 15°C/min., 500 cycles
Power/Thermal Cycling	5	T _{operating} = min to max, V _{in} = min to max, full load, 100 cycles
Design Marginality	5	T _{min} -10°C to T _{max} +10°C, 5°C steps, V _{in} = min to max, 0-105% load
Humidity	5	85°C, 85% RH, 1000 hours, 2 minutes on and 6 hours off
Solderability	15 pins	MIL-STD-883, method 2003

- Extensive characterization testing of all SynQor products and manufacturing processes is performed to ensure that we supply robust, reliable product. Contact the factory for official product family qualification documents.

OPTIONS

SynQor provides various options for Enable Logic and Pin Length for this family of DC/DC converters. Please consult the [last page](#) for information on available options.

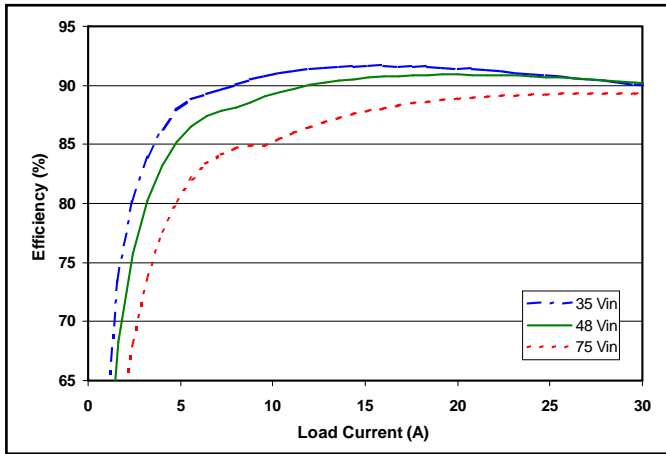

Figure 1: Efficiency at nominal output voltage vs. load current for minimum, nominal, and maximum input voltage at 25°C.

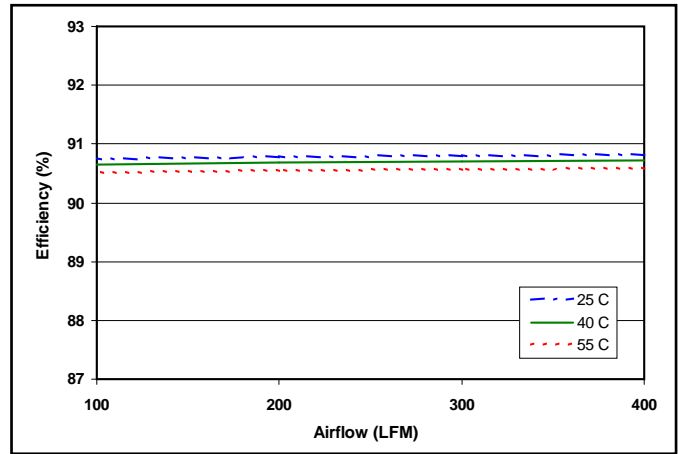

Figure 2: Efficiency at nominal output voltage and 60% rated power vs. airflow rate for ambient air temperatures of 25°C, 40°C, and 55°C (nominal input voltage).

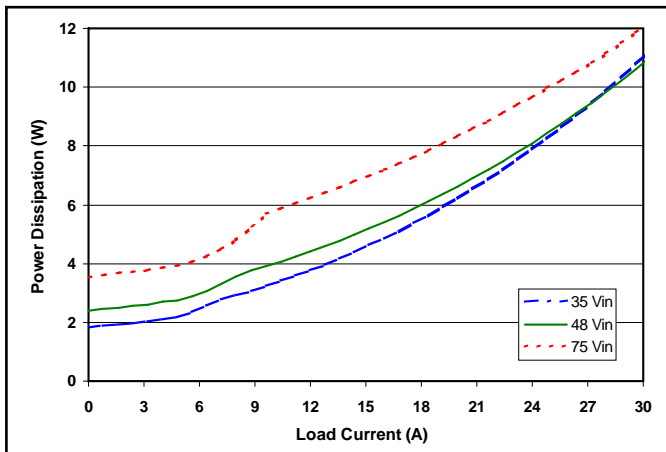

Figure 3: Power dissipation at nominal output voltage vs. load current for minimum, nominal, and maximum input voltage at 25°C.

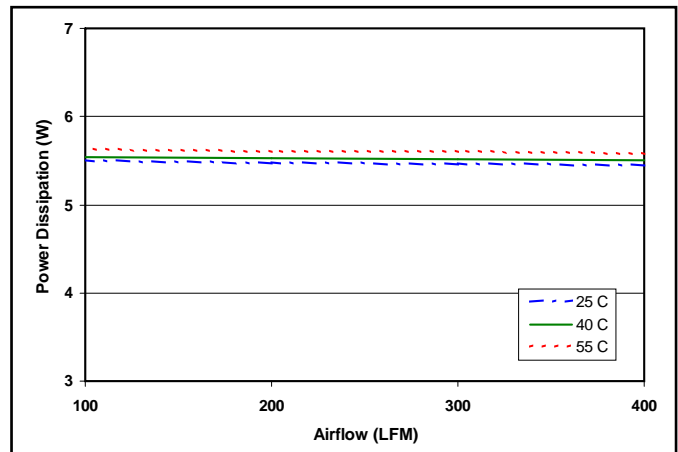

Figure 4: Power dissipation at nominal output voltage and 60% rated power vs. airflow rate for ambient air temperatures of 25°C, 40°C, and 55°C (nominal input voltage).

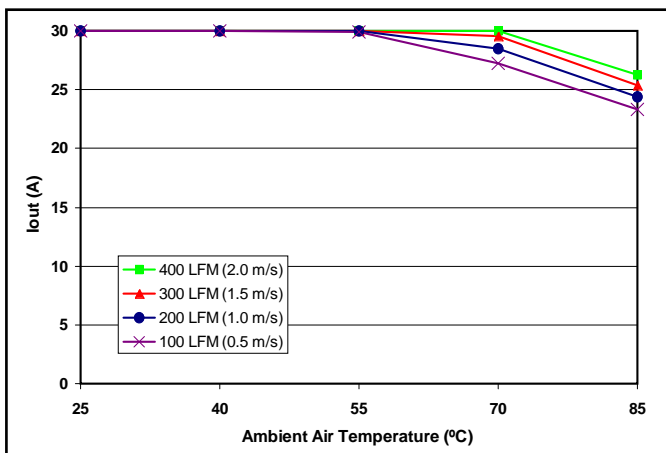

Figure 5: Maximum output power-derating curves vs. ambient air temperature for airflow rates of 100 LFM through 400 LFM with air flowing from pin 3 to pin 1 (nominal input voltage).

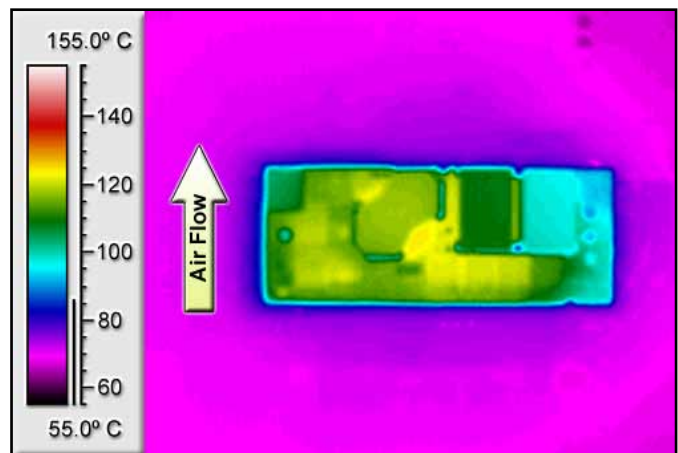

Figure 6: Thermal plot of converter at 28.5 amp load current (94.05W) with 70°C air flowing at the rate of 200 LFM. Air is flowing across the converter from 3 to pin 1 (nominal input voltage).

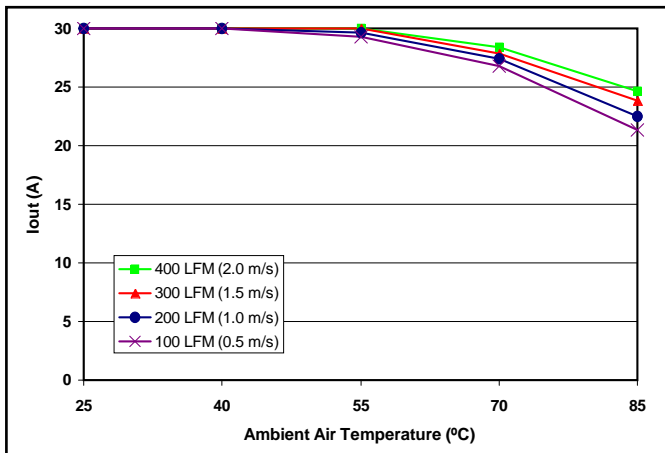

Figure 7: Maximum output power derating curves vs. ambient air temperature for airflow rates of 100 LFM through 400 LFM with air flowing across the converter from pin input to output (nominal input voltage).

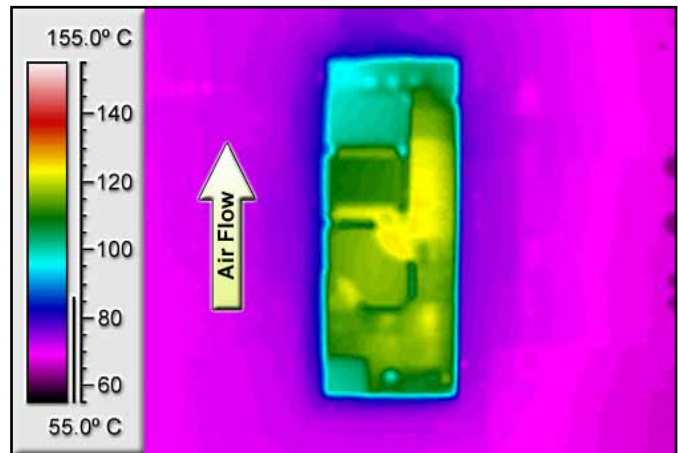

Figure 8: Thermal plot of converter at 27.4 amp load current (90.42W) with 70°C air flowing at the rate of 200 LFM. Air is flowing across the converter from input to output (nominal input voltage).

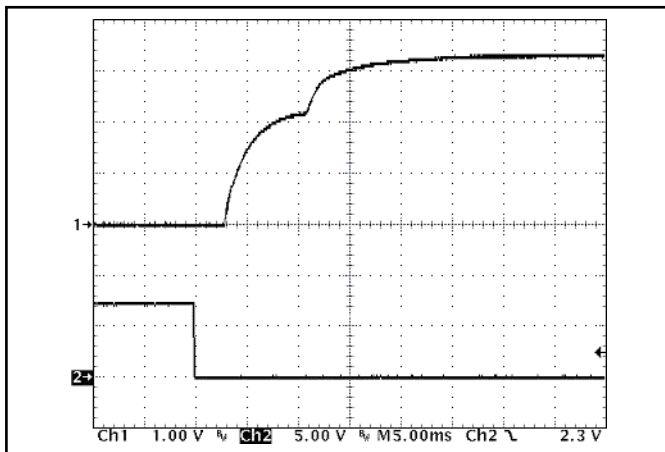

Figure 9: Turn-on transient at full load (resistive load) (5 ms/div). Load cap: 10 μ F, 100 m Ω ESR tantalum capacitor and 1 μ F ceramic capacitor. Input voltage pre-applied. Ch 1: V_{out} (1V/div), Ch 2: ON/OFF input (5V/div).

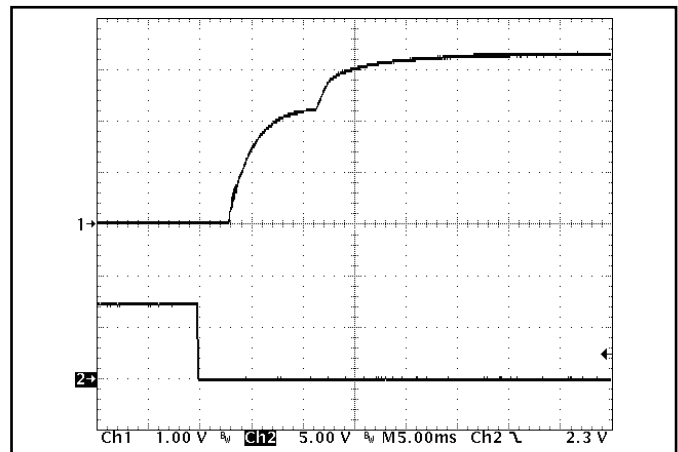

Figure 10: Turn-on transient at zero load (10 ms/div). Load cap: 10 μ F, 100 m Ω ESR tantalum capacitor and 1 μ F ceramic capacitor. Ch 1: V_{out} (1V/div), Ch 2: ON/OFF input (5V/div).

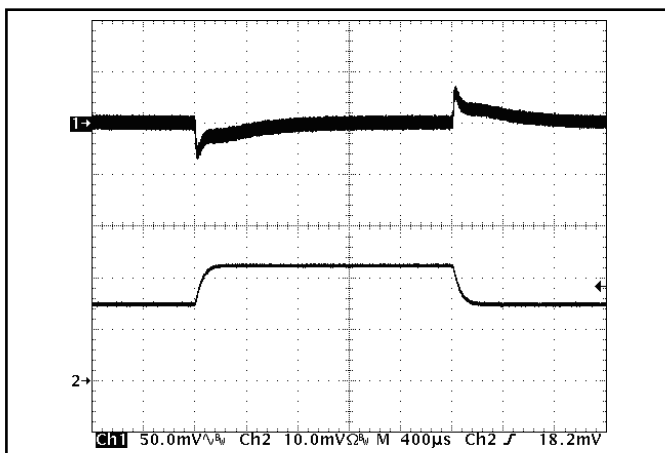

Figure 11: Output voltage response to step-change in load current (50%-75%-50% of $I_{out(max)}$; $dl/dt = 0.1A/\mu s$). Load cap: 10 μ F, 100 m Ω ESR tantalum cap and 1 μ F ceramic cap. Ch 1: V_{out} (50mV/div), Ch 2: I_{out} (10A/div).

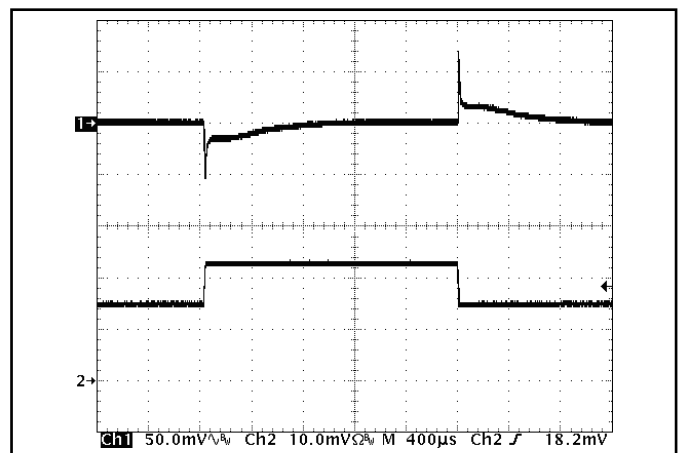

Figure 12: Output voltage response to step-change in load current (50%-75%-50% of $I_{out(max)}$; $dl/dt = 1A/\mu s$). Load cap: 470 μ F, 30 m Ω ESR tantalum cap and 1 μ F ceramic cap. Ch 1: V_{out} (50mV/div), Ch 2: I_{out} (10A/div).

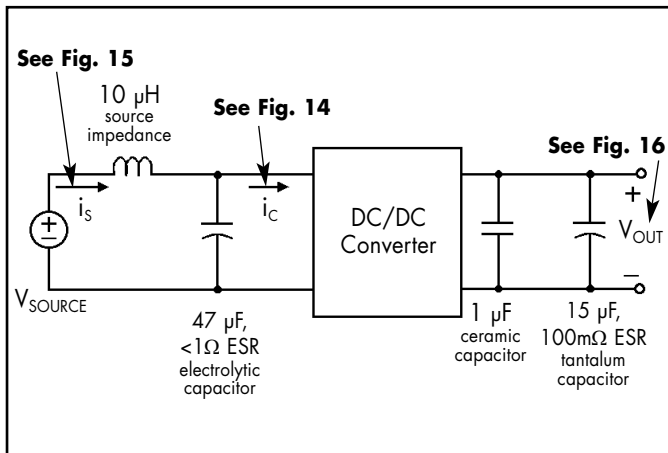

Figure 13: Test set-up diagram showing measurement points for Input Terminal Ripple Current (Figure 14), Input Reflected Ripple Current (Figure 15) and Output Voltage Ripple (Figure 16).

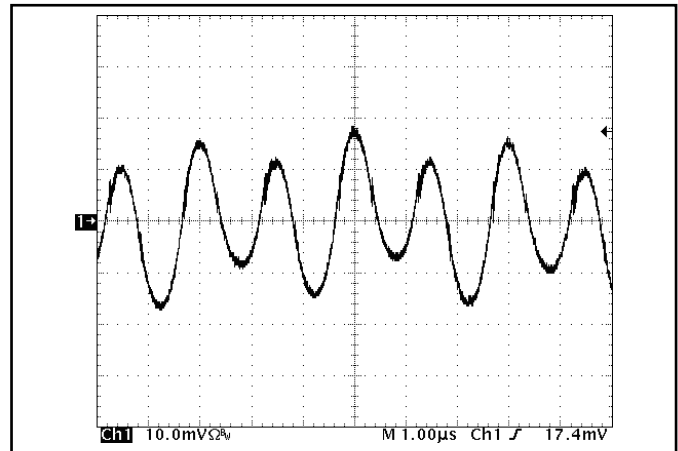

Figure 14: Input Terminal Ripple Current, i_c , at full rated output current and nominal input voltage with $10\ \mu\text{H}$ source impedance and $47\ \mu\text{F}$ electrolytic capacitor (50 mA/div). Bandwidth: 250MHz. See Figure 13.

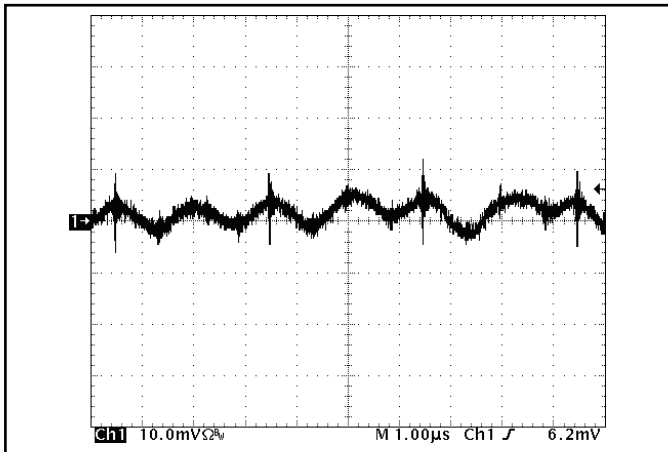

Figure 15: Input reflected ripple current, i_s , through a $10\ \mu\text{H}$ source inductor, using a $47\ \mu\text{F}$ electrolytic input capacitor (2mA/div). Bandwidth: 250MHz. See Figure 13.

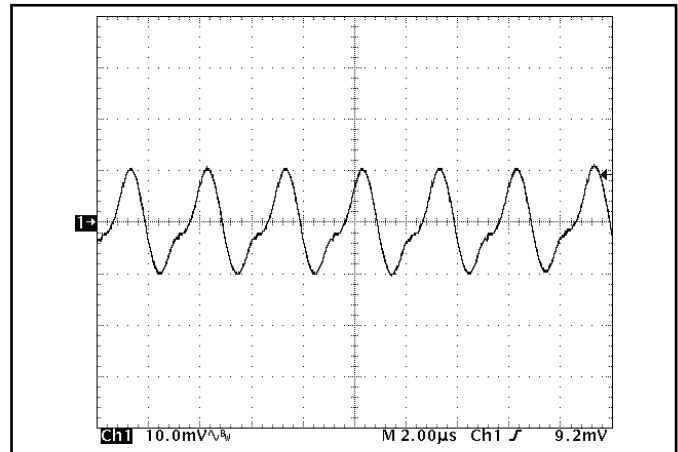

Figure 16: Output voltage ripple at nominal input voltage and rated load current (10 mV/div). Load capacitance: $1\ \mu\text{F}$ ceramic capacitor and $15\ \mu\text{F}$ tantalum capacitor. Bandwidth: 20 MHz. See Figure 13.

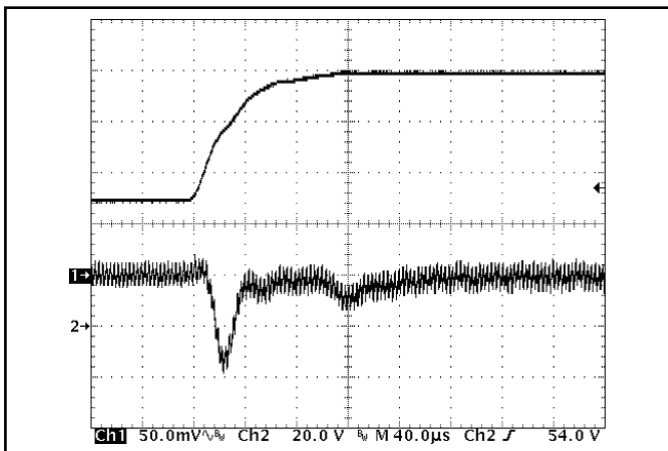

Figure 17: Output voltage response to step-change in input voltage (50V to 100V in 100µS), at 15A load current. Load cap: $15\ \mu\text{F}$ $100\text{m}\Omega$ ESR tantalum capacitor and $1\ \mu\text{F}$ ceramic cap. Ch 1: V_{out} (50mV/div), Ch 2: V_{in} (20V/div).

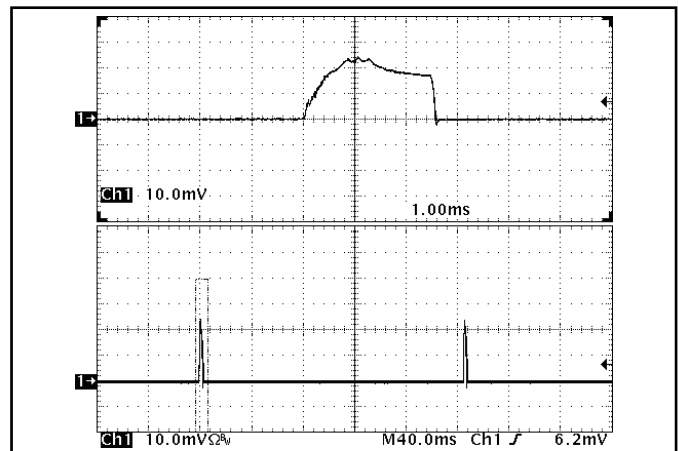

Figure 18: Load current (20A/div) as a function of time when the converter attempts to turn on into a $15\text{m}\Omega$ short circuit. Top trace (1ms/div) is an expansion of the on-time portion of the bottom trace (40ms/div).

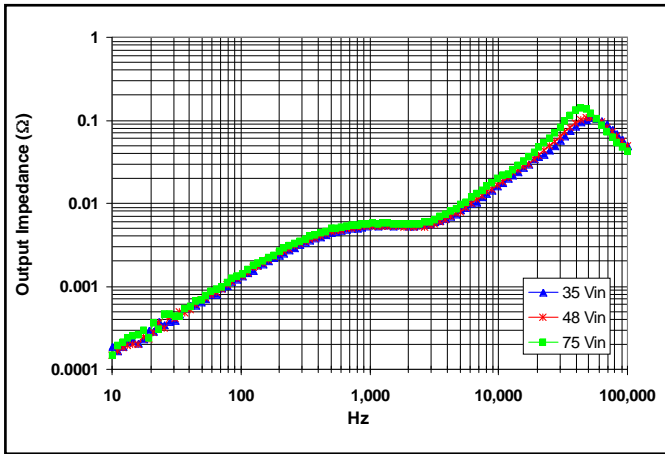

Figure 19: Magnitude of incremental output impedance ($Z_{out} = v_{out}/i_{out}$) for minimum, nominal, and maximum input voltage at full rated power.

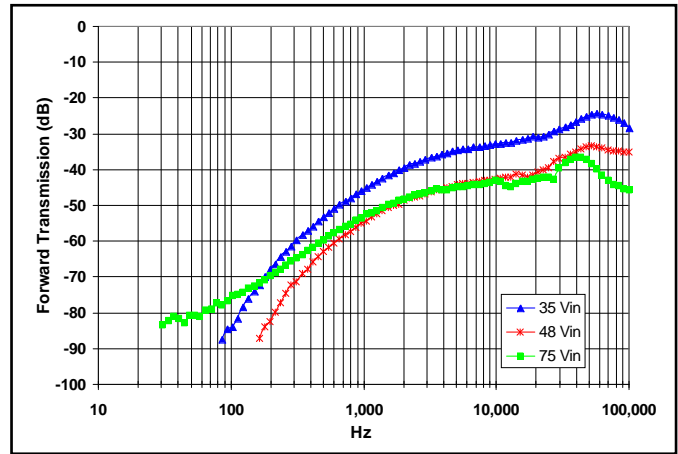

Figure 20: Magnitude of incremental forward transmission ($FT = v_{out}/v_{in}$) for minimum, nominal, and maximum input voltage at full rated power.

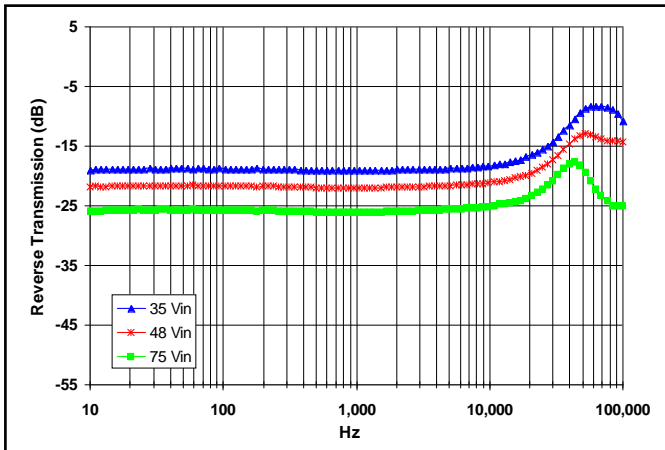

Figure 21: Magnitude of incremental reverse transmission ($RT = i_{in}/i_{out}$) for minimum, nominal, and maximum input voltage at full rated power.

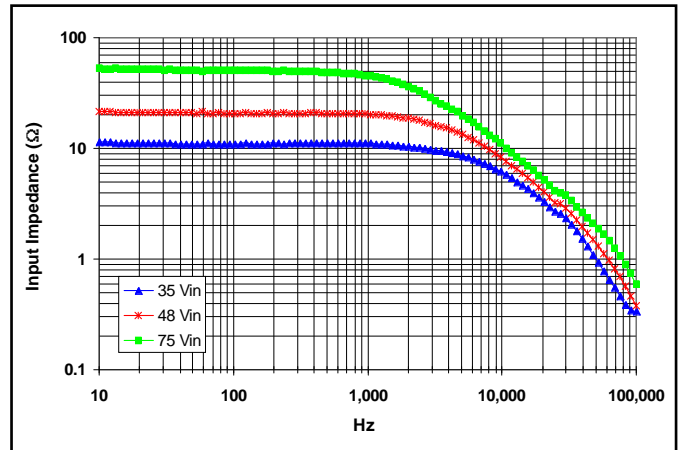

Figure 22: Magnitude of incremental input impedance ($Z_{in} = v_{in}/i_{in}$) for minimum, nominal, and maximum input voltage at full rated power.

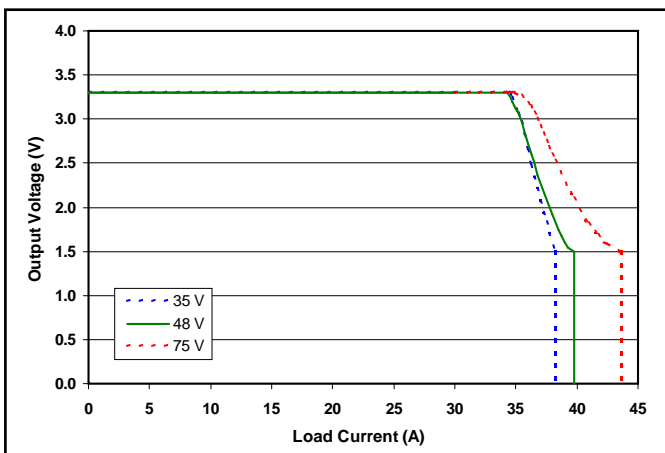

Figure 23: Output voltage vs. load current showing typical current limit curves and converter shutdown points.

BASIC OPERATION AND FEATURES

The single stage power converter switches at a fixed frequency for predictable EMI performance. Rectification of the transformer's output is accomplished with synchronous rectifiers. These devices, which are MOSFETs with a very low on-state resistance, dissipate far less energy than Schottky diodes. This is the primary reason that the PowerQor converter has such high efficiency, even at very low output voltages and very high output currents.

Dissipation throughout the converter is so low that it does not require a heatsink for operation. Since a heatsink is not required, the PowerQor converter does not need a metal baseplate or potting material to help conduct the dissipated energy to the heatsink. The PowerQor converter can thus be built more simply and reliably using high yield surface mount techniques on a PCB substrate.

The PowerQor series of eighth-brick, quarter-brick and half-brick converters uses the industry standard footprint and pin-out configuration.

CONTROL FEATURES

REMOTE ON/OFF (Pin 2): The ON/OFF input, Pin 2, permits the user to control when the converter is on or off. This input is referenced to the return terminal of the input bus, Vin(-). There are two versions of the converter that differ by the sense of the logic used for the ON/OFF input.

In the positive logic version, the ON/OFF input is active high (meaning that a high turns the converter on). In the negative logic version, the ON/OFF signal is active low (meaning that a low turns the converter on). Figure A details five possible circuits for driving the ON/OFF pin. Figure B is a detailed look of the internal ON/OFF circuitry.

REMOTE SENSE(+) (Pins 7 and 5): The SENSE(±) inputs correct for voltage drops along the conductors that connect the converter's output pins to the load.

Pin 7 should be connected to Vout(+) and Pin 5 should be connected to Vout(-) at the point on the board where regulation is desired. A remote connection at the load can adjust for a voltage drop only as large as that specified in this datasheet, that is

$$[V_{out(+)} - V_{out(-)}] - [V_{sense(+)} - V_{sense(-)}] \leq \text{Sense Range \%} \times V_{out}$$

Pins 7 and 5 must be connected for proper regulation of the output voltage. If these connections are not made, the converter will deliver an output voltage that is slightly higher than its specified value.

Note: the output over-voltage protection circuit senses the voltage across the output (pins 8 and 4) to determine when it should trigger, not the voltage across the converter's sense leads (pins 7 and 5). Therefore, the resistive drop on the board should be small enough so that output OVP does not trigger, even during load transients.

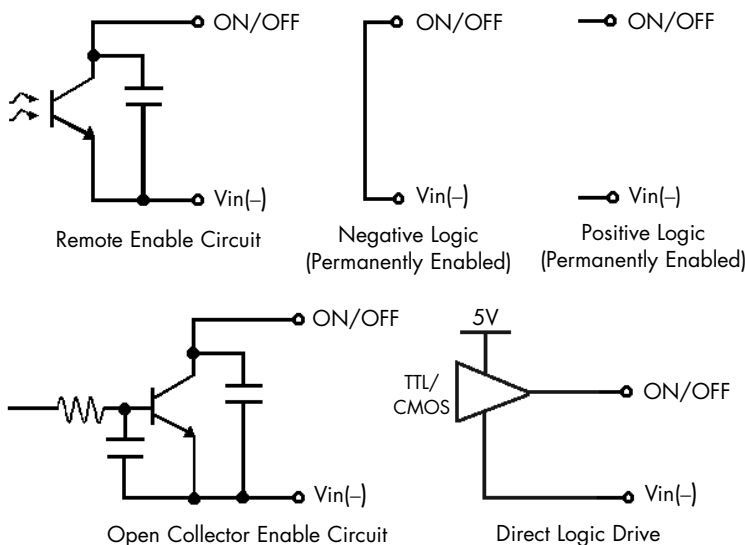

Figure A: Various circuits for driving the ON/OFF pin.

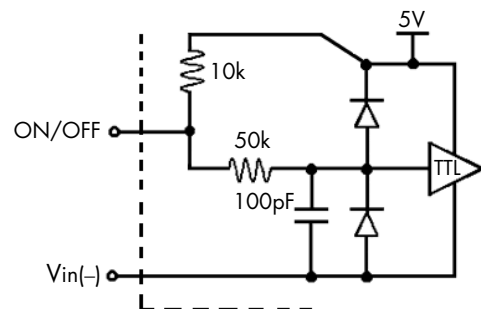

Figure B: Internal ON/OFF pin circuitry

OUTPUT VOLTAGE TRIM (Pin 6): The TRIM input permits the user to adjust the output voltage across the sense leads up or down according to the trim range specifications.

To decrease the output voltage, the user should connect a resistor between Pin 6 and Pin 5 (SENSE(-) input). For a desired decrease of the nominal output voltage, the value of the resistor should be

$$R_{\text{trim-down}} = \left(\frac{511}{\Delta\%} \right) - 10.22 \text{ (k}\Omega\text{)}$$

where

$$\Delta\% = \left| \frac{V_{\text{nominal}} - V_{\text{desired}}}{V_{\text{nominal}}} \right| \times 100\%$$

To increase the output voltage, the user should connect a resistor between Pin 6 and Pin 7 (SENSE(+) input). For a desired increase of the nominal output voltage, the value of the resistor should be

$$R_{\text{trim-up}} = \left(\frac{5.11V_{\text{OUT}}(100+\Delta\%)}{1.225\Delta\%} - \frac{511}{\Delta\%} - 10.22 \right) \text{ (k}\Omega\text{)}$$

where

$$V_{\text{OUT}} = \text{Nominal Output Voltage}$$

Figure C graphs the relationship between the trim resistor value and $R_{\text{trim-up}}$ and $R_{\text{trim-down}}$, showing the total range the output voltage can be trimmed up or down.

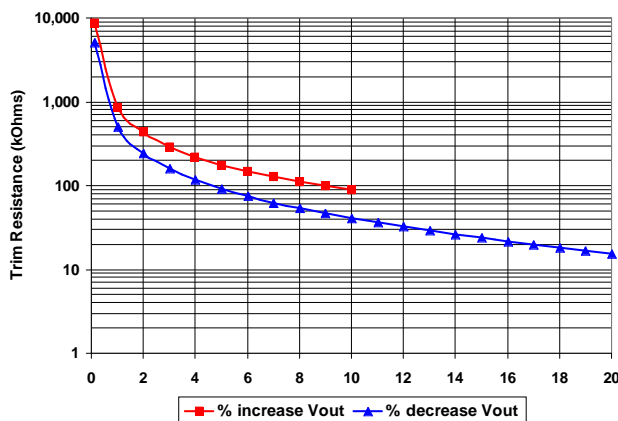

Figure C: Trim Graph for 3.3Vout module

Note: the TRIM feature does not affect the voltage at which the output over-voltage protection circuit is triggered. Trimming the output voltage too high may cause the over-voltage protection circuit to engage, particularly during transients.

It is not necessary for the user to add capacitance at the Trim pin. The node is internally bypassed to eliminate noise.

Total DC Variation of Vout: For the converter to meet its full specifications, the maximum variation of the DC value of Vout, due to both trimming and remote load voltage drops, should not be greater than that specified for the output voltage trim range.

PROTECTION FEATURES

Input Under-Voltage Lockout: The converter is designed to turn off when the input voltage is too low, helping avoid an input system instability problem, described in more detail in the application note titled "Input System Instability". The lockout circuitry is a comparator with DC hysteresis. When the input voltage is rising, it must exceed the typical Turn-On Voltage Threshold value (listed on the specification page) before the converter will turn on. Once the converter is on, the input voltage must fall below the typical Turn-Off Voltage Threshold value before the converter will turn off.

Output Current Limit: Once the output current reaches the current-limit inception point, the converter will decrease the output voltage as the output current increases. However, once the impedance of the short across the output is small enough to make the output voltage drop below the specified Output DC Current-Limit Shutdown Voltage, the converter turns off (see Figure 23).

The converter then enters a "hiccup mode" where it repeatedly turns on and off at a 5 Hz (nominal) frequency with a 5% duty cycle until the short circuit condition is removed. This prevents excessive heating of the converter or the load board.

Output Over-Voltage Limit: If the voltage across the output pins exceeds the Output Over-Voltage Protection threshold, the converter will immediately stop switching. This prevents damage to the load circuit due to 1) excessive series resistance in output current path from converter output pins to sense point, 2) a release of a short-circuit condition, or 3) a release of a current limit condition. Load capacitance determines exactly how high the output voltage will rise in response to these conditions. After 200 ms the converter will automatically restart.

Over-Temperature Shutdown: A temperature sensor on the converter senses the average temperature of the module. The thermal shutdown circuit is designed to turn the converter off when the temperature at the sensed location reaches the Over-Temperature Shutdown value. It will allow the converter to turn on again when the temperature of the sensed location falls by the amount of the Over-Temperature Shutdown Restart Hysteresis value.

APPLICATION CONSIDERATIONS

Input System Instability: This condition can occur because any DC/DC converter appears incrementally as a negative resistance load. A detailed application note titled "Input System Instability" is available on the SynQor website which provides an understanding of why this instability arises, and shows the preferred solution for correcting it.

Application Circuits: Figure D below provides a typical circuit diagram which details the input filtering and voltage trimming.

Input Filtering and External Capacitance: Figure E below provides a diagram showing the internal input filter components. This filter dramatically reduces input terminal ripple current, which otherwise could exceed the rating of an external input electrolytic capacitor. The recommended external input capacitance is specified in the "Input Characteristics" section. More detailed information is available in the application note titled "EMI Characteristics" on the SynQor website.

Startup/Restart Inhibit Period: The Restart Inhibit Period ensures that the converter will remain off for approximately 200ms once it is shut down. When an output short is present, this generates a 5Hz "hiccup mode," which prevents the converter from overheating. In all, there are five ways that the converter can be shut down that initiate a Restart Inhibit Period:

- Input Under-Voltage Lockout
- Output Over-Voltage Protection
- Over Temperature Shutdown
- Current Limit
- Turned off by the ON/OFF input

Figure E shows four turn-on scenarios, where a Restart Inhibit Period is initiated at t_1 , t_2 , and t_3 :

A Startup Inhibit Period is initiated when the input voltage is brought up from zero voltage during initial startup, beginning as the input voltage reaches approximately 10V. At the end of the Startup Inhibit Period (typically 10mS), if the ON/OFF pin has been active for at least 1ms, and the input voltage is above the Under-Voltage Lockout threshold, the output turns on with the Typical Turn-On Time. This is shown at time t_0 .

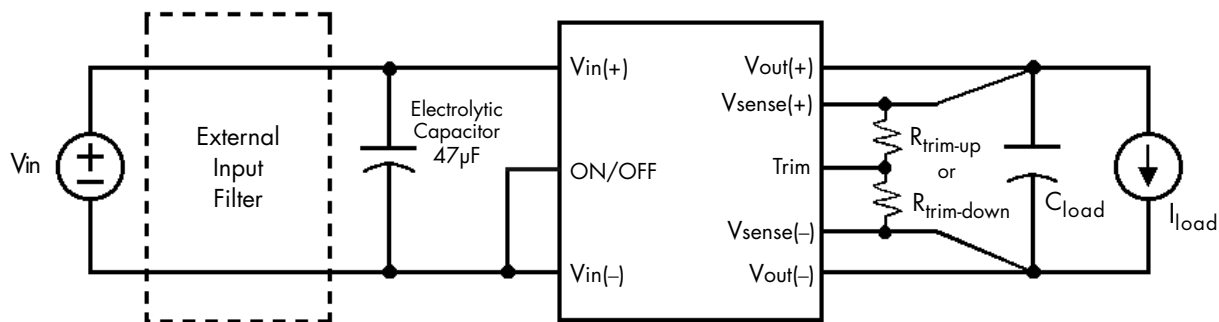

Figure D: Typical application circuit (negative logic unit, permanently enabled).

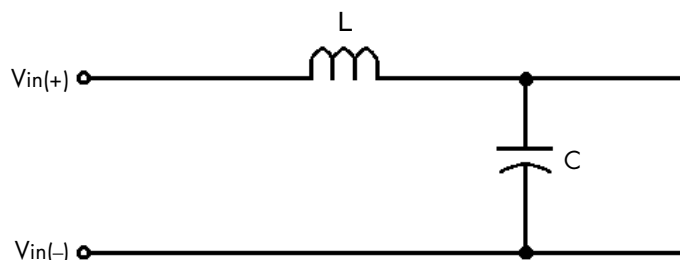

Figure E: Internal Input Filter Diagram (component values listed on the specifications page).

At time t_1 , the input voltage falls below the Input Under-Voltage Lockout threshold. This disables the unit and initiates a Restart Inhibit Period. During the Restart Inhibit Period, if the input voltage again exceeds the UVLO threshold, the unit cannot be enabled again until the Restart Inhibit Period has elapsed. Once this occurs, the output turns on with the Typical Turn-On Time.

At time t_2 , the ON/OFF pin disables the unit and initiates a Restart Inhibit Period. During the Restart Inhibit Period, if the ON/OFF pin is again activated, the unit cannot be enabled again until the Restart Inhibit Period has elapsed. Once this occurs, the output turns on with the Typical Turn-On Time.

When the ON/OFF pin goes high after t_3 , and the Restart Inhibit Period has elapsed, the output turns on approximately 1.6ms after the ON/OFF pin is activated, with the Typical Turn-On Time.

If the Under-Voltage Lockout threshold has not been satisfied at the end of either Inhibit Period, the unit will remain disabled until the input voltage exceeds the UVLO threshold. Once this occurs, the output turns on with the Typical Turn-On Time.

If the ON/OFF pin is activated after either Inhibit Period has elapsed, the output will turn on approximately 1.6ms after the ON/OFF pin is activated, with the Typical Turn-On Time.

RoHS Compliance: The EU led RoHS (Restriction of Hazardous Substances) Directive bans the use of Lead, Cadmium, Hexavalent Chromium, Mercury, Polybrominated Biphenyls (PBB), and Polybrominated Diphenyl Ether (PBDE) in Electrical and Electronic Equipment. This SynQor product is available as 6/6 RoHS compliant. For more information please refer to SynQor's RoHS addendum available at our [RoHS Compliance / Lead Free Initiative](#) web page or e-mail us at rohs@synqor.com.

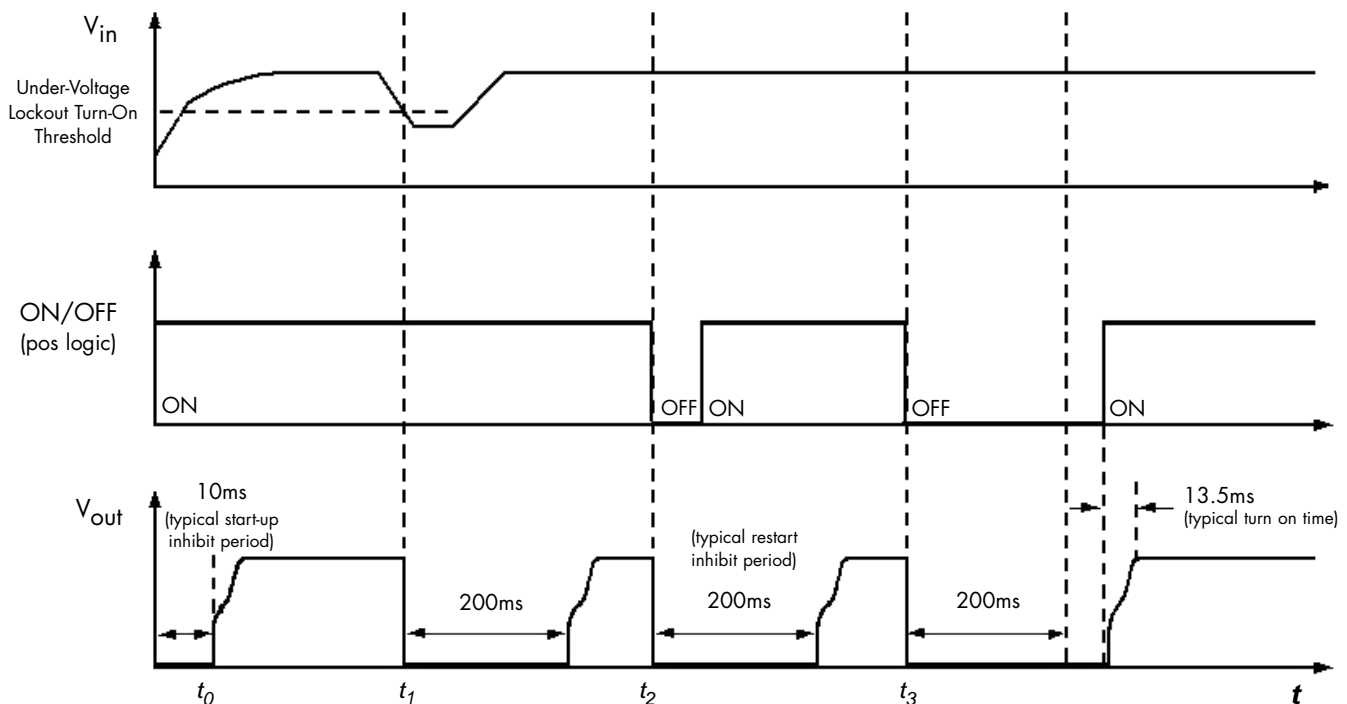

Figure F: Startup Inhibit Period (turn-on time not to scale)

